

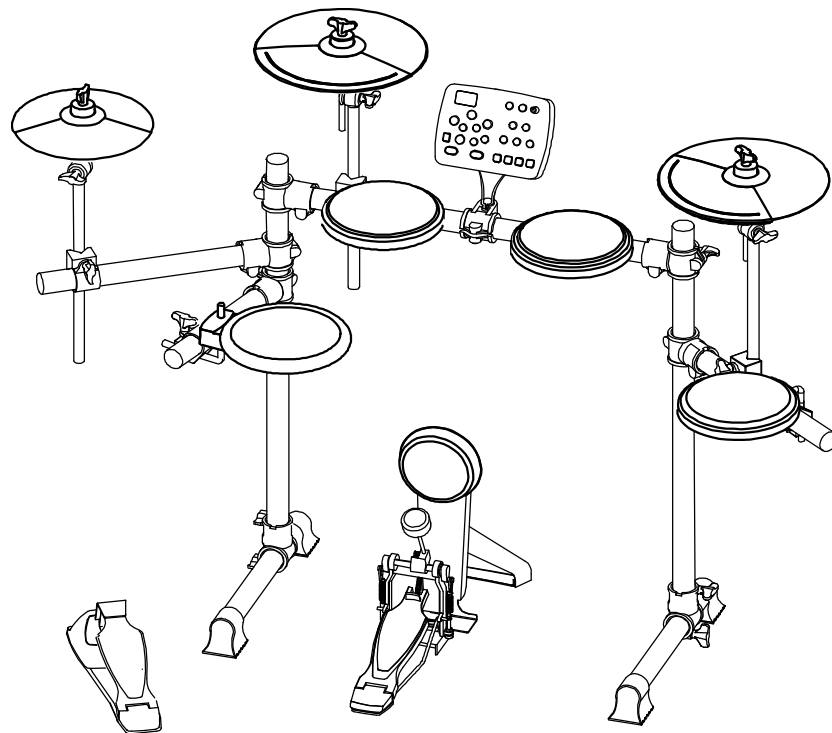

HD-006 DIGITAL DRUM USER'S MANUAL



CAUTION

CAUTION

Any changes or modifications in construction of this device which are not expressly approved by the party responsible for compliance could void the user's authority to operate the equipment.

WARNING

When using electrical products, basic safety precautions should always be followed, including the following:

NOTE: This equipment has been tested and found to comply with the limits for a Class B digital device, pursuant to Part 15 of the FCC Rules.

Also, this equipment has been tested and found to comply with the limits for following standard:

EN55022-2006

EN55024:1998/+A1:2001/+A2:2003

EN55013:2001/+A1:2003/+A3:2006

EN61000-3-2:2006

EN61000-3-3:1995/+A1:2001/+A2:2003

These limits are designed to provide reasonable protection against harmful interference in a residential installation. This equipment generates, uses, and can radiate radio frequency energy and, if not installed and used in accordance with the instructions, may cause harmful interference to radio communications. However, there is no guarantee that interference will not occur in a particular installation. If this equipment does cause harmful interference to radio or television reception, which can be determined by turning the equipment off and on, the user is encouraged to try to correct the interference by one or more of the following measures:

- Reorient or relocate the receiving antenna.
- Increase the separation between the equipment and receiver.
- Connect the equipment into an outlet on a circuit different from that to which the receiver is connected.
- Consult the dealer or an experienced radio/TV technician for help.

TAKING CARE OF YOUR DRUM

! DO NOT ATTEMPT TO OPEN THE UNIT OR MAKE ANY CHANGE IN THE CIRCUITS OR PARTS OF THE UNIT.

SERVICE AND MODIFICATION

This product should be serviced by qualified service personnel when,

- w the power supply cord or the plug of the adaptor has been damaged,
- w liquid has been spattered into the unit or it has been exposed to rain,
- w the instrument does not appear to operate normally or exhibits a marked change in performance,
- w the instrument has been dropped or the cabinet has been damaged.

HANDLING AND TRANSPORT

- w Never apply excessive force to the controls, connectors, pads or other parts of the instrument.
- w Always unplug cables by gripping the plug firmly, not by pulling on the cable.
- w Physical shocks caused by dropping, bumping, or placing heavy objects on the instrument can result in scratches and/or more serious damage.
- w Carefully check the amplifier volume control before stating to play. Excessive volume can cause permanent hearing loss.

CLEANING

- w Clean the unit with a dry or light-wet soft cloth. Do not use paint thinner or petrochemical based polishes.

LOCATION

- w Do not expose the drum to the following conditions to avoid deformation, discoloration, or more serious damage,

- direct sunlight (near a window),
- high temperatures (near a heat source, outside, or in a car during the daytime),
- rain or excessive humidity,
- excessive dust,
- strong vibration.

- w The unit shall not be exposed to dripping or splashing and no objects filled with liquids, such as vases, shall be placed on the unit.
- w The drum contains digital circuitry and may cause interference if placed too close to radio or television receivers. If interference occurs, move the drum further away from the affected equipment.

POWER

- w Only use attached power adaptor.
- w Turn the power switch off when the drum is not in use.
- w To avoid damage to the drum and other devices to which it is connected, turn the power switches of all related devices off prior to connection or disconnection of audio cables.
- w Turn the power off if the main cable of the adaptor is damaged or the instrument is spattered with liquid.
- w Do not switch the unit on and off in quick succession, this places an undue load on the electronic components.
- w Unplug the AC power cord during an electrical storm.
- w Avoid plugging the AC adaptor into the same AC outlet as appliances with high power consumption, such as electric heaters or ovens.

CONTENTS TABLE

INSTALLATION.....	5
SOUND MODULE.....	9
CONTROL PANEL	9
BOTTOM PANEL	10
PLAY PAD.....	11
TURN ON THE POWER	11
PLAYING PADS	11
MASTER VOLUME	11
DRUM KIT	12
KIT SELECT	12
KIT EDIT	12
CHANGE THE VOICE AND VOLUME OF THE PAD	12
EXIT FROM THE EDIT MODE.....	13
PATTERN	14
PLAY THE PATTERN	14
EXERCISE WITH THE PATTERN	14
METRONOME	15
RECORD	16
RECORD STANDBY	16
RECORDING	16
STOP AND SAVE	17
PLAYBACK.....	17
USB & MIDI	18
VOICE LIST	19
SPECIFICATIONS	21

INSTALLATION

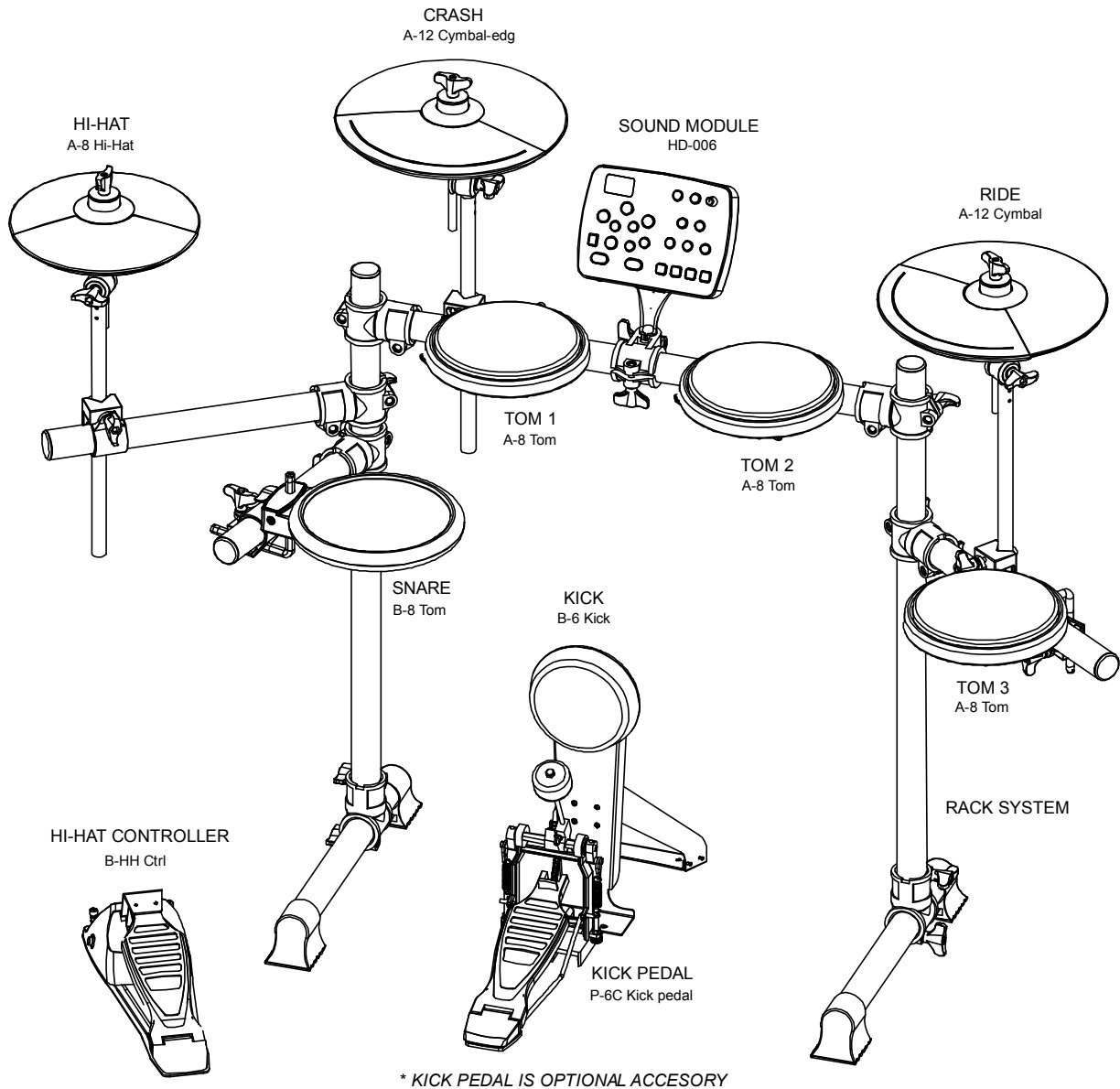

The drawing shows a complete drum kit after installation.

Each drum pad, cymbal pad and Hi-Hat control pedal has its part number underneath the component name for your reference in installation. The part number is also printed on the part packing box.

Power adaptor and connection cables are not shown in the drawing.

INSTALLATION

RACK SYSTEM

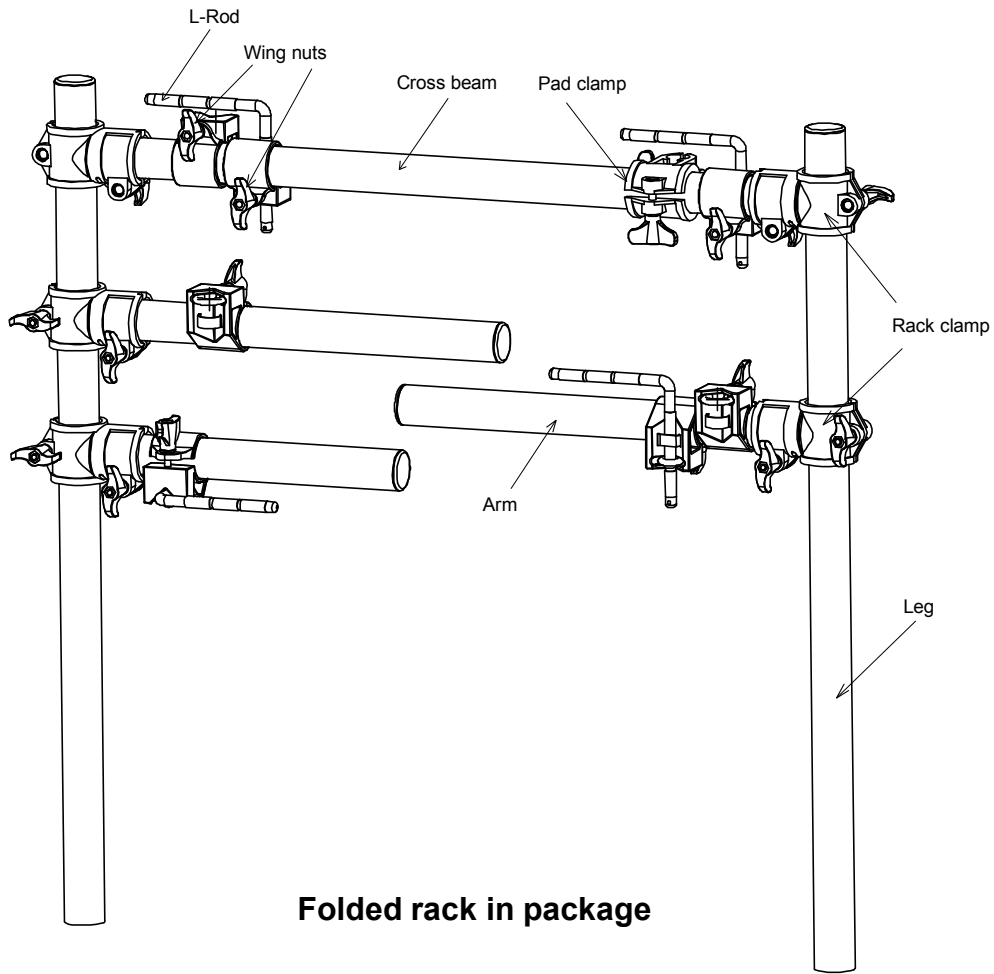

Folded rack in package

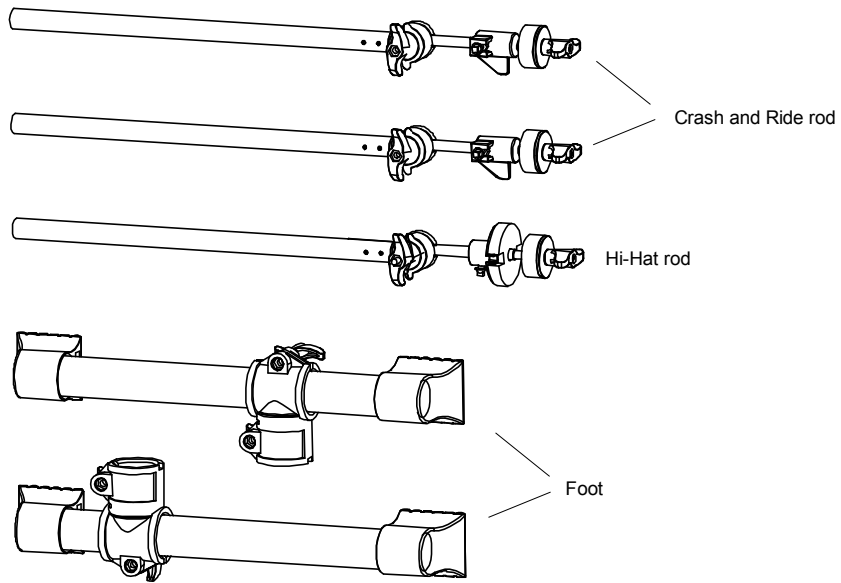

Other parts of the rack system

INSTALLATION

RACK INSTALLATION

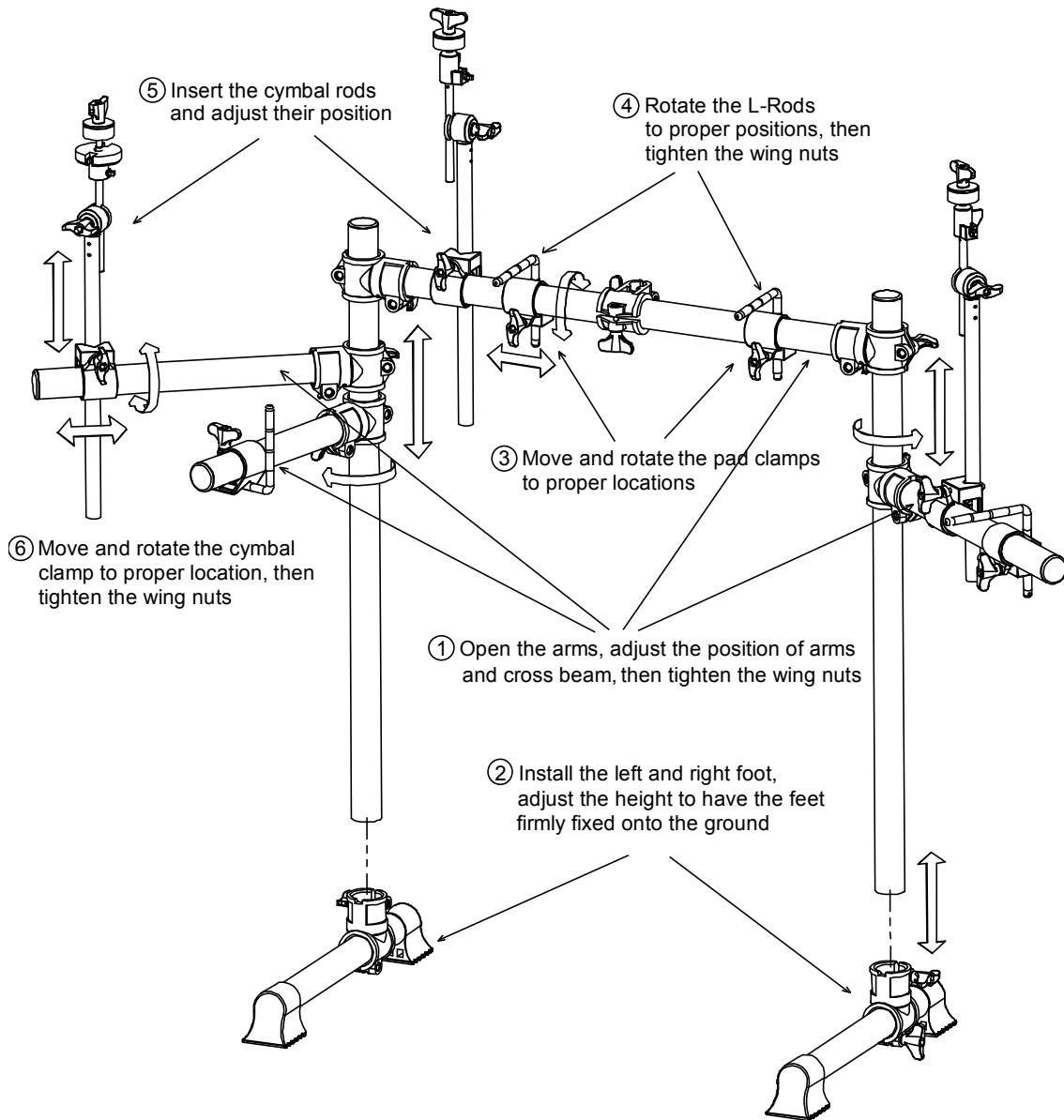

INSTALLATION

COMPONENTS INSTALLATION

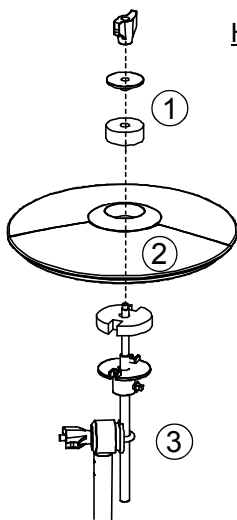

Hi-Hat Installation

1. Remove the wing nut, washer and felt pad
2. Put the Hi-Hat into the rod along with parts removed in step 1. Fasten the wing nut.
3. Adjust the angle and height of the rod before tightening the wing nut.

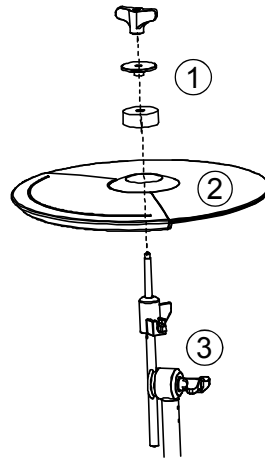

Crash and Ride Installation

1. Remove the wing nut, washer and felt pad
2. Put the cymbal pad into the rod along with parts removed in step 1. Fasten the wing nut moderately to give the pad a little bit wobbling like the real acoustic cymbal.

Note: Crash and Ride have different part numbers. Please refer to indication on page 5.

3. Adjust the angle of the rod then tighten the wing nut.

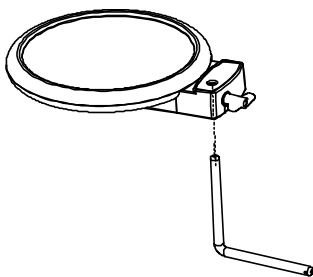

Snare Installation

1. Insert the snare into the L-Rod, then tighten the wing nut.
2. Adjust the angle of the L-Rod then tighten the wing nut in the clamp.

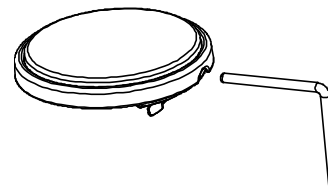

Tom Installation

1. Insert the tom into the L-Rod, then tighten the wing nut.

Note: All the toms use the same pad.

2. Adjust the angle of the L-Rod before tightening the wing nut in the clamp.

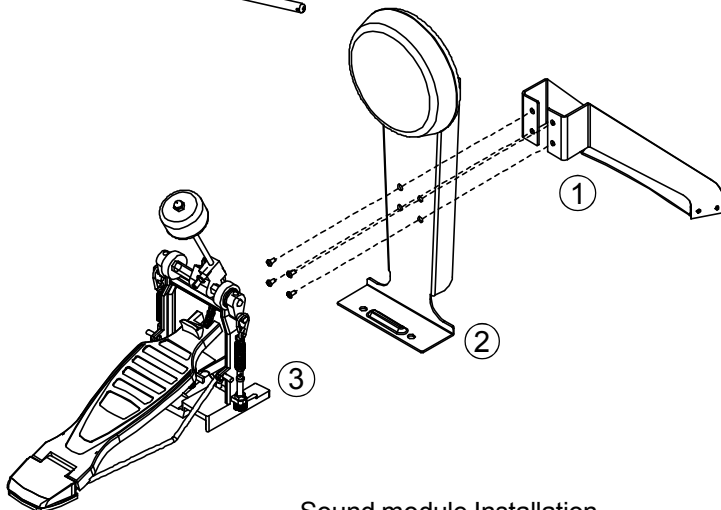

Kick Installation

1. Align holes in the kick stand (2) with these in the bracket (1) then fasten them with screws.
2. Insert tongue of the kick stand into slot of the pedal (3). Tighten the wing nut on the pedal level to fix it.

Sound module Installation

1. Align holes in supporting board with these in sound module then fasten them with screws.
2. Insert rod of the supporting board into the clamp, then tighten the wing nut.

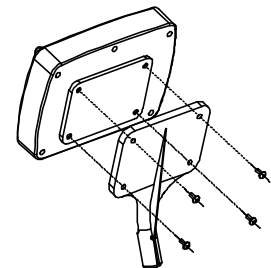

Finalizing the Installation

Adjust arms, clamps and rods to the best position you like to finalize the installation.

Electronic Connection

Please refer to the SOUND MODULE Chapter for electronic connection.

SOUND MODULE

CONTROL PANEL

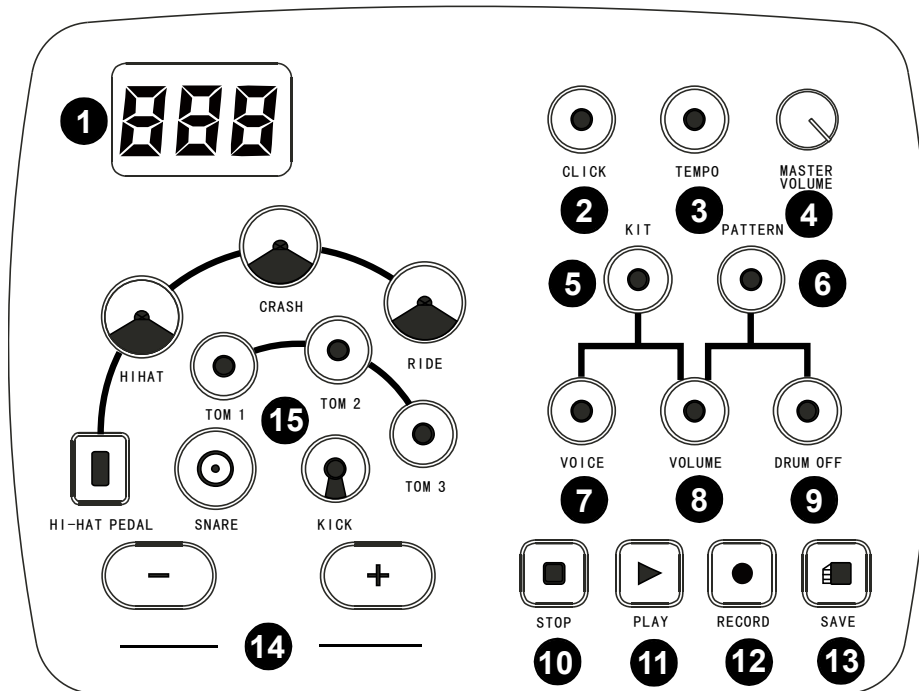

- (1) **Display:** The display is a 3-digital 7-Segment LED type showing Information such as Kit number, Voice number etc. .
- (2) **CLICK Button:** Metronome On/Off switch
- (3) **TEMPO Button:** Change the tempo of the metronome, it is also used for recording and Pattern playing.
- (4) **MASTER VOLUME Knob:** Rotate the knob clockwise to increase the master volume and counter-clockwise to decrease the master volume
- (5) **KIT Button:** Enter the Drum kit selection mode
- (6) **PATTERN Button:** Enter the Pattern play mode
- (7) **VOICE Buttons:** Enter the voice assignment mode
- (8) **VOLUME Button:** Enter the volume adjustment mode
- (9) **DRUM OFF Button:** Mute drum sound in the pattern
- (10) **STOP Buttons:** Stop the pattern playing or recording
- (11) **PLAY Button:** Play the Pattern
- (12) **RECOED Buttons:** Enter the record mode
- (13) **SAVE Button:** Save the record and setting
- (14) **+/- Buttons:** It is universal in the kit, pattern selection and volume setting etc.
- (15) **Pad Select Buttons:** Select a pad in kit edit and display pad performance in pattern playing.

RESET

Press and hold down both + and - button when turn on the power until rSE appears on the display. The factory setting will be restored and recorded contents erased.



SOUND MODULE

BOTTOM PANEL

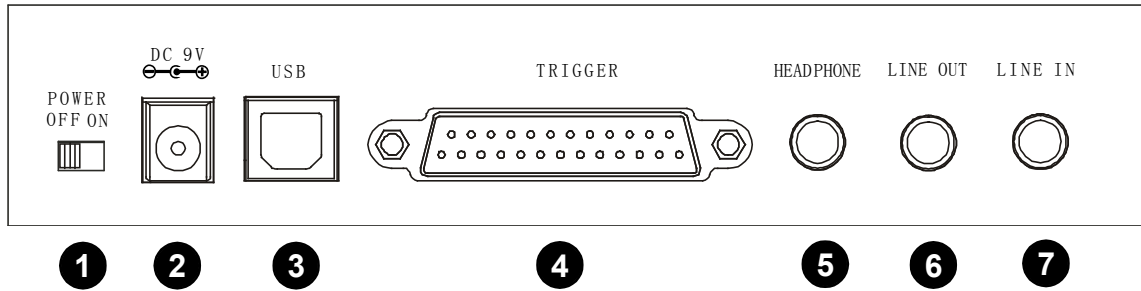

(1) Power Switch: Turn On/Off the sound module

Note: After you turn the power off, do not turn it on immediately. Wait at least five seconds so that the electronic circuits can be properly reset.

(2) Power In Jack: Plug in the DC cable of the attached adaptor

(3) USB Jack: The USB connector allows you to connect the drum directly to your computer's USB port. The USB interface is compatible with Windows XP/Vista, Windows 7 and MAC. The computer will recognize the drum as Audio Device.

(4) Pad Trigger Connector: Each pad and Hi-Hat control pedal have labeled cables. All cables are merged into a single connector. Plug the cable into the jack of the corresponding component, and then plug in the connector here.

(5) Headphone Jack: The drum has a stereo headphone jack. You can play in total silence without disturbing others in the room by plugging a set of headphones into the socket.

(6) Line Out Jack: There is no built-in speaker in the drum. Line Out of stereo audio output delivers the drum output signal to external amplification, such as home stereo, PA system or other stand alone amplifiers. If you connect to an external mono system, stereo/mono adapter is recommended.

(7) Line In Jack: Line In of stereo audio input jacks will mix the supplied signal with the internal drum sound. It can be used to connect to items such as CD players, MP3 player etc.

PLAY PAD

TURN ON THE POWER

- (1) Turn down the external audio device connected with the drum.
- (2) Press the POWER button while don't strike pad or press the Hi-Hat control pedal.
- (3) Turn on external devices connected.
- (4) Strike the pad and adjust the volume to a proper level.

PLAYING PADS

All pads have striking force sensitivity feature. Strike the pad harder to make a higher volume and strike the pad softer to make a lower volume.

Playing Tom Drum

Strike the central position to create a sound.

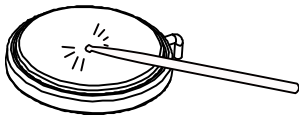

Playing Cymbal

Strike rubber area of the crash and ride pad to create a cymbal sound.

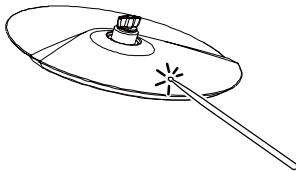

The crash has choke feature. Strike the crash pad, its sound will sustain. Squeeze the edge portion, the sound will be mute.

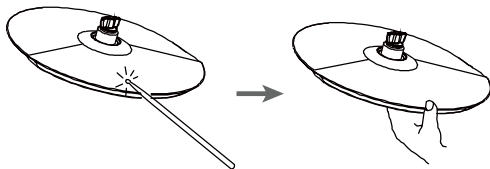

Playing Snare Drum

Strike the central position (head) of the pad to make head sound, strike the rim of the pad to make a rim sound.

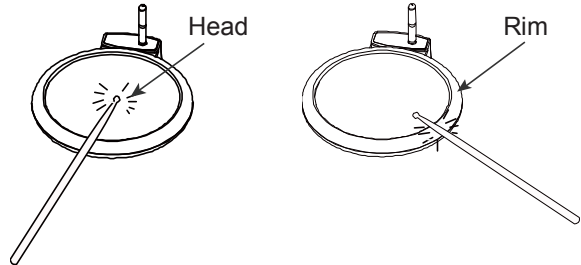

Playing Hi-Hat

- (1) Strike the Hi-Hat pad without pressing the Hi-Hat control pedal to make an open Hi-Hat sound.
- (2) Strike the Hi-Hat pad while fully pressing the Hi-Hat control pedal to make a close Hi-Hat sound.
- (3) Strike the Hi-Hat pad while pressing the Hi-Hat control pedal gradually, the consecutive open sound changes to close sound.
- (4) Press the Hi-Hat pedal down quickly to make Hi-Hat pedal sound.

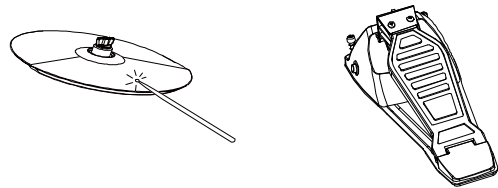

Playing Kick Drum

Press the Kick drum pedal to make a kick drum sound.

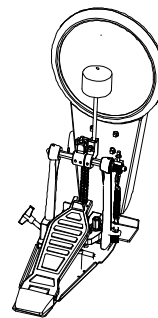

MASTER VOLUME

Rotate the MASTER VOLUME knob to turn the master volume up/down. Rotate the knob clockwise to increase the volume; rotate the knob counter-clockwise to decrease the volume.



DRUM KIT

This drum has 20 preset drum kits for your choice. The kit is a combination of different instrument voices assigned to each pad which has unitary style for performance. Any kit could be edited and saved. After the power is turned on, the kit mode is engaged automatically the KIT button is lit and the kit number is shown on the display.

In other operation modes, you could press the KIT button to enter the kit mode directly.

KIT SELECT

Press the + or - button to select the kit you desire from the kit list below ranging 01 - 20. The default kit number is 01. When you re-enter the kit mode, the kit number will be one you selected last time.

Kit No.	Kit Name	Kit No.	Kit Name
01	Pop	11	HeavyBeat
02	Electric	12	Metal
03	Jazz	13	Rock
04	BeatBox	14	Punk
05	808	15	Carbon
06	Fireball	16	Disco
07	Magnet	17	TightRope
08	Dry	18	Smashing
09	Machine	19	Largeness
10	Room	20	Funky

KIT EDIT

After selecting a kit, you can change the voice and its volume of each pad and save them.

CHANGE THE VOICE AND VOLUME OF THE PAD

Press the VOICE button to assign a voice to the pad and press the VOLUME button to change its volume. The pressed button will light up and blink.

Before editing, you should select a pad by pressing the pad select button. The selected pad button will light up and blink, and then you can hear its voice.

Please note that the snare has head and rim parts; Hi-Hat has open and close voices. Press the corresponding button twice to select an alternative part of this pad and the light color of the button becomes blue. The default pad is Tom 1. Or, it is the pad you edited last time.

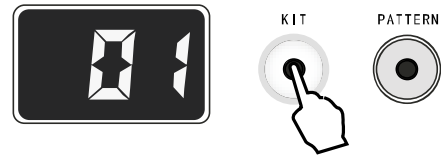

Enter the kit mode

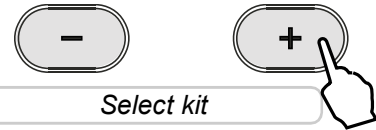

Select kit

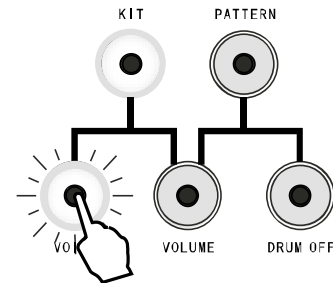

Enter the voice change mode

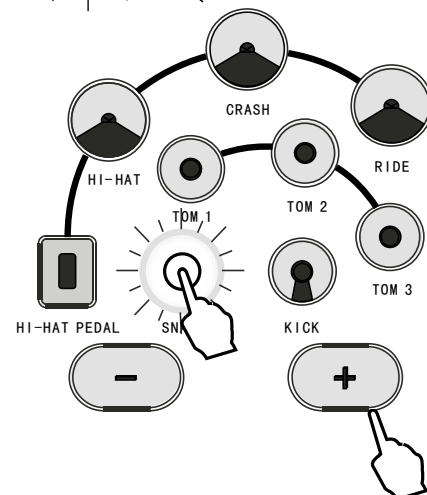

Select pad and assign voice

The following procedure is for voice assignment. The way of changing its volume is the same.

While the VOICE button and the selected pad button blink, its current voice number will appear on the display. Use the +, - button to change the voice number ranging 1 - 184. Press both + and - button simultaneously, its original voice will be restored. All assignable voices are listed in the Appendix VOICE LIST.

You can test the voice by striking the pad or pressing the pad button.

 **Tip:** Press and hold down the + or - button, the data will change consecutively. It is helpful for you to change the number in large range.

You can change the voice of another pad by pressing another button.

Or, you can adjust the volume of this pad by pressing the VOLUME button and the VOLUME button will light up and blink. The display shows current volume. Then, use the +/- button to change the volume ranging 0 - 127.

 **Tip:** An easy way to select a part is to hit the pad or press the Hi-Hat pedal directly. The corresponding button will light up and blink. Please note that a too slight striking cannot trigger a proper selection.

EXIT FROM THE EDIT MODE

Press the blinking VOICE or VOLUME button again to exit and turn to the kit select mode. Its indicator will be off. Please note that your setting will be lost when you turn off the power. You can also exit by pressing the SAVE button. In this way, **your setting is nonvolatile even when you turn off the power.**

 **Tip:** You can restore the factory setting. Please refer to description about the Reset on page 9.

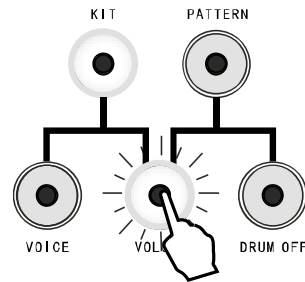

Enter the volume change mode

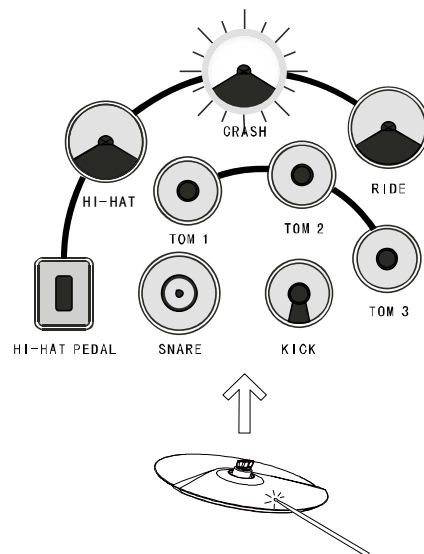

Easy way to select pad

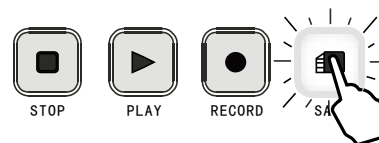

Save the editing

PATTERN

There are 50 built-in patterns for your enjoyment and exercise.

PLAY THE PATTERN

Press the PATTERN button to engage the pattern mode and its indicator will light up. The pattern number with "P" in front will appear and blink on the display. Use the + or - button to select a pattern. Press the PLAY button to start playing and the display will show measure number. Pad select buttons will flash to indicate which pad is performed.

When the pattern playing is finished, it'll restart from the very beginning. Press the STOP button to stop the playing.

During the playing, you can also select a pattern by pressing the + or - button, the next/last pattern number will appear on the display. After selecting, the new pattern will start play from the first measure.

During the playing, you can change its tempo. Press the TEMPO button, its indicator will light up and blink. The current tempo will appear on the display and blink. Use the + or - button to change the tempo ranging 40 - 240. Press both + and - button simultaneously, the tempo will recover the original value. Wait 3 seconds or press the TEMPO button again, the display will recover the measure.

EXERCISE WITH THE PATTERN

During the pattern playing, you can also play pads.

All patterns consist of drum pattern and orchestral background music. You can mute the drum sound and play by yourself accompanied with background music. Press the DRUM OFF button to mute the drum sound and the button will light up.

The volume of the pattern is adjustable. Press the VOLUME button, the button will light up and blink while the current volume will be displayed. Use the + or - button to adjust the volume. Wait 3 seconds or press the VOLUME button again, the display will recover the measure.

Press the KIT button or press the PATTERN button again to exit and turn to the Kit mode.

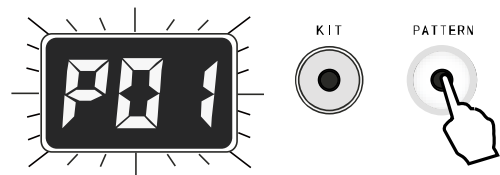

Enter the pattern mode



Select pattern



Play pattern

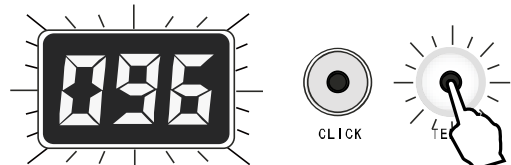

Change the tempo

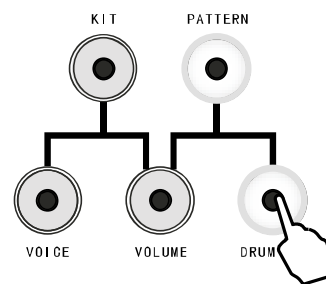

Mute drum sound

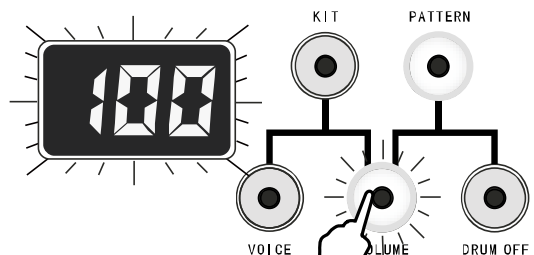

Adjust pattern volume

METRONOME

Press the CLICK button to activate the metronome, its indicator will light up and flash according to current tempo.

 **Note:** During the pattern playing, the metronome cannot sound but the CLICK button will flash if the metronome is engaged.

Press the button again to stop it.

The speed of the metronome is determined by tempo value. It is adjustable. Press the TEMPO button. Its indicator will light up and blink. The current tempo will appear on the display and blink. Use the + or - button to change the tempo ranging 40 - 240. Press both + and - button simultaneously, the tempo will restore the default value 120. Wait 3 seconds or press the TEMPO button again, the display will turn back to the previous window.

 **Tip:** Press and hold down the + or - button, the data will change consecutively. It is helpful for you to change the tempo in large range.

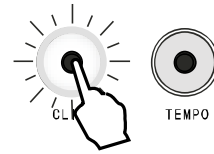

Activate the metronome

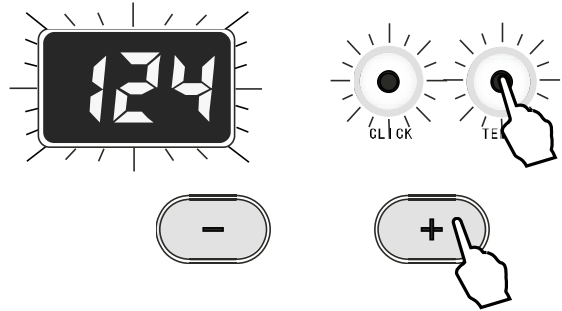

Change the tempo

RECORD

This drum provides facilities to record one piece of your performance and save it as pattern 51. The recording could be accompanied with pattern. Before recording, you should prepare necessary settings including selecting drum kit, metronome and tempo setting, pattern selecting etc.

RECORD STANDBY

Press the RECORD button to enter the record mode. The button will light up and blink to indicate the recorder is standby. The PATTERN button will light up automatically so that you can record your performance with a pattern. The display shows the current pattern number; you can select another pattern by the + or - button. The volume and tempo of the pattern is adjustable, please refer to the <PATTERN> section of this manual.

If you do not want drum sound in the pattern, press the DRUM OFF button to mute it.

If you don't want to use the pattern at all, press the PATTERN button, its indicator will be turned off and "OFF" will appear on the display.

You can make the metronome ready by pressing the CLICK button and the button will flash.

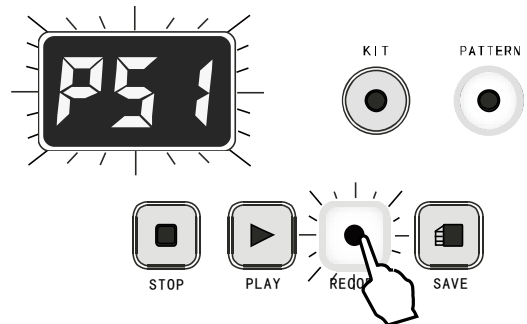

Enter the record mode

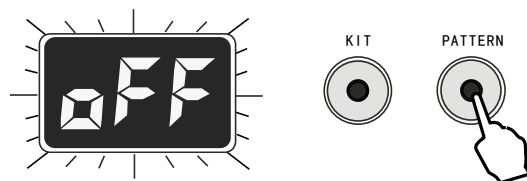

Turn off the pattern

RECORDING

There are two types of the record.

* Record free performance - You should turn off the pattern for this type of record.

* Record with a pattern - In this way, you can either use its background music or add your performance to the pattern. The pattern will play repeatedly until you stop the recording. Please note that even if you stop the recording before the pattern is over, the remaining measure of the pattern will be kept in your recording.

There are two ways to start recording.

* Auto Start: Press the RECORD button again, after four beats count-in, the record will start immediately no matter you strike the drum pad or not.

* Synchro Start: The record will start as soon as you strike any pad.

When record started, the RECORD button stops blinking and remains lit. The metronome will sound as soon as record starts if the metronome is engaged. The recording measure will appear on the display.

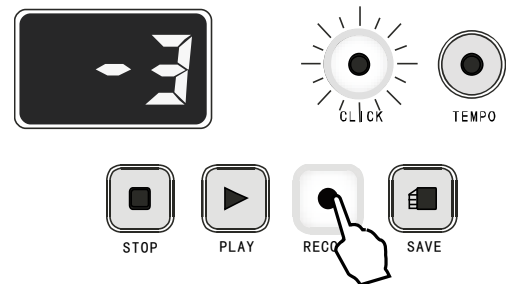

Count-in

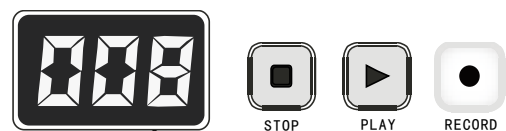

Measure

Recording

RECORD

Press the RECORD button again or press the STOP button to terminate the recording. The RECORD button blinks and is ready for the next recording. The new recording over-writes the contents of the previous recording in unit of measure. In this way, you can edit your recording.

 **Tip:** The Auto Start mode is recommended for over-write and record with the pattern.

The metronome sound is for reference only. It is not recorded.

STOP AND SAVE

When the recording is finished and RECORD button blinks, press the SAVE button to save it as Pattern 51. The RECORD button turns off and the PATTERN button keeps lit. The display shows P51. **your setting is nonvolatile even when you turn off the power.**

When the RECORD button blinks, press the STOP button to discard the current record. The RECORD button turns off and the PATTERN button keeps lit. The display shows the pattern number you selected before the recording. Please note that your current record will be lost.

Press the KIT number anytime, the recording will be terminated and the drum will turn to the Kit mode. Your current record will be lost.

PLAYBACK

Enter the Pattern mode, select P51, press the PLAY button to play back your recording. Please refer to the <PATTERN> section of this manual for details.

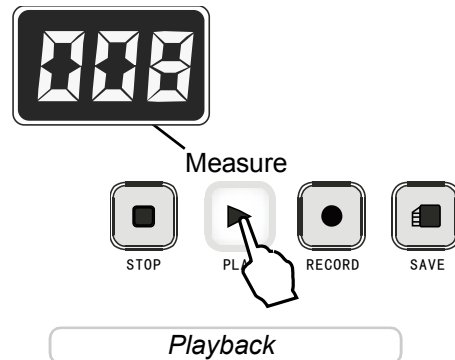
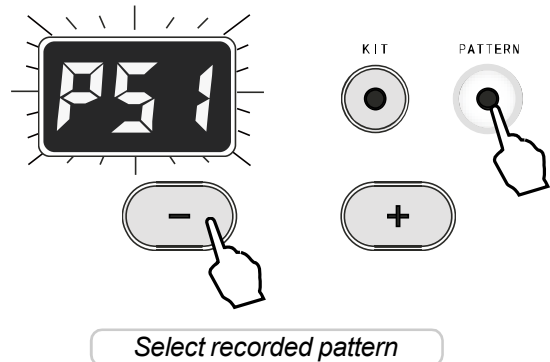
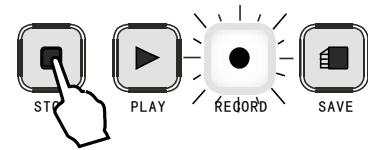

USB & MIDI

MIDI stands for Musical Instrument Digital Interface. This is a world wide standard communication interface that enables electronic musical instruments and computers to communicate with each other so that instructions and other data can pass between them. This exchange of information makes it possible to create a system of MIDI instruments and devices that offers far greater versatility and control than that is available with isolated instruments. Whether you interface with computers, sequencers, expanders or other equipments your musical horizons will be greatly enhanced. For instance, you can edit your playing in computer or play back MIDI song from computer while play the drum.

USB - The USB connector allows you to connect the drum directly to your computer. It can connected without driver installation under the Windows XP, Windows Vista & MAC OSX environment. The drum will be recognized as USB Audio device to receive and transmit the same MIDI messages described above.

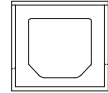

USB

MIDI APPLICATION CHART

Function	Transmitted	Recognized	Remarks
Basic Channel	10	1-16	
Note Number	0-127	0-127	
Velocity: Note ON	1-127	0-127	
Note OFF	64	0-127	
Major Controls:			
B9h 04h xxh	Yes	X	Hi-Hat pedal control
Bxh 79h 00h	Yes	Yes	Reset All Controller
Bxh 7Bh 00h	Yes	Yes	All Notes OFF
Program Change	X	Yes *	
System Exclusive	Yes	Yes **	
RPN	X **	Yes **	
NRPN	Yes	Yes **	

* Chanel 10 supports Bank 0 only

** If you need detailed information about Exclusive, RPN and NRPN, please contact your vender

Note: Transmitted note through Chanel 10 for each pad is fixed as below:

PAD	NOTE	PAD	NOTE
Tom1	48	Ride	51
Tom2	45	Hi-Hat Open	46
Tom3	41	Hi-Hat Close	42
Snare	38	Hi-Hat Pedal	44
Snare Rim	37	Kick	36
Crash	55		

VOICE LIST

No.	Description	No.	Description	No.	Description
GM		041	HighAgogo	SNARE	
001	HighQ	042	LowAgogo	081	Snare 1
002	Slap	043	Cabasa	082	Snare 2
003	ScraPush	044	Maracas	083	Snare 3
004	ScraPull	045	ShortWhist	084	Snare 4
005	Stick	046	LongWhist	085	Snare 5
006	SquarClick	047	ShortGuiro	086	Snare 6
007	MetroClick	048	LongGuiro	087	Snare 7
008	MetroBell	049	Claves	088	Snare 8
009	KickDrum2	050	Hi W-Block	089	Snare 9
010	KickDrum1	051	Lo W-Block	090	Snare 10
011	SideStick	052	MuteCuica	091	Snare 11
012	SnareDrum2	053	OpenCuica	092	Snare 12
013	HandClap	054	MuteTriang	093	Snare 13
014	SnareDrum1	055	OpenTriang	094	Snare 14
015	LoFloTom2	056	Cabasa	095	Snare 15
016	CloseHH	057	Shaker	096	Snare 16
017	LowFloTom1	058	Belltree	097	Snare 17
018	PedalHH	059	Castanets	098	Snare 18
019	LowTom	060	MuteSurdo	099	Snare 19
020	OpenHi-hat	061	OpenSurdo	100	Snare 20
021	Low-midTom	KICK		101	Snare 21
022	Hi-midTom	062	Kick 1	102	Snare 22
023	CrashCymb1	063	Kick 2	103	Snare 23
024	RHighTom	064	Kick 3	104	Snare 24
025	RideCymb1	065	Kick 4	105	Snare 25
026	ChCymbal	066	Kick 5	106	Snare 26
027	RideBell	067	Kick 6	107	Snare 27
028	Tambourine	068	Kick 7	108	Snare 28
029	SplashCymb	069	Kick 8	109	Snare 29
030	Cowbell	070	Kick 9	110	Snare 30
031	CrashCymb2	071	Kick 10	111	Snare 31
032	VibraSlap	072	Kick 11	112	Snare 32
033	RideCymb2	073	Kick 12	113	Snare 33
034	HiBongo	074	Kick 13	114	Snare 34
035	LowBongo	075	Kick 14	115	Snare 35
036	MuteConga	076	Kick 15	SIDE STICK	
037	HiConga	077	Kick 16	116	SideStick 1
038	LowConga	078	Kick 17	117	SideStick 2
039	HighTimbal	079	Kick 18	118	SideStick 3
040	LowTimbale	080	Kick 19		

VOICE LIST

No.	Description	No.	Description	No.	Description
	CLOSED HI-HAT	142	Open Hi-Hat 12	164	Low Tom5
119	Closed Hi-Hat 1	143	Open Hi-Hat 13	165	Low Tom6
120	Closed Hi-Hat 2	HI TOM		166	Low Tom7
121	Closed Hi-Hat 3	144	Hi Tom 1	167	Low Tom8
122	Closed Hi-Hat 4	145	Hi Tom 2	CRASH	
123	Closed Hi-Hat 5	146	Hi Tom 3	168	Crash 1
124	Closed Hi-Hat 6	147	Hi Tom 4	169	Crash 2
125	Closed Hi-Hat 7	148	Hi Tom 5	170	Crash 3
126	Closed Hi-Hat 8	149	Hi Tom 6	RIDE	
127	Closed Hi-Hat 9	150	Hi Tom 7	171	Ride 1
128	Closed Hi-Hat 10	151	Hi Tom 8	172	Ride 2
129	Closed Hi-Hat 11	MID TOM		173	Ride 3
130	Closed Hi-Hat 12	152	Mid Tom 1	174	Ride 4
	OPEN HI-HAT	153	Mid Tom 2	175	Ride 5
131	Open Hi-Hat 1	154	Mid Tom 3	176	Ride 6
132	Open Hi-Hat 2	155	Mid Tom 4	OTHER PERCUSSION	
133	Open Hi-Hat 3	156	Mid Tom 5	177	Percussion 1
134	Open Hi-Hat 4	157	Mid Tom 6	178	Percussion 2
135	Open Hi-Hat 5	158	Mid Tom 7	179	Percussion 3
136	Open Hi-Hat 6	159	Mid Tom 8	180	Percussion 4
137	Open Hi-Hat 7	LOW TOM		181	Percussion 5
138	Open Hi-Hat 8	160	Low Tom1	PEDAL HI-HAT	
139	Open Hi-Hat 9	161	Low Tom2	182	Pedal Hi-Hat 1
140	Open Hi-Hat 10	162	Low Tom3	183	Pedal Hi-Hat 2
141	Open Hi-Hat 11	163	Low Tom4	184	Pedal Hi-Hat 3

SPECIFICATIONS

Configuration	3 X 8" Tom (without rim), 8" Snare (with rim feature), 12" Crash cymbal (with choke feature), 12" Ride cymbal, 8" Hi-Hat, 6" Kick, Hi-Hat pedal
Voice	184
Drum Kit	20 preset kits
Pattern	50, Full and Mute drum mode
Pad Button	play drum sound with led blink
Pad Edit	Voice, Volume,
Tempo	default 120; range 40 ~240
Metro	On/Off
Record	1 editable song in overwrite mode
Easy Reset	holding button+ and button- when power on
Display	3x7LED
Power	9V DC
Aux. Socket	Headphone, Line In/Out, USB, Power In DC9V

All specifications are subject to change without notice



HD-006 DIGITAL DRUM USER'S MANUAL

Shanghai Huaxin Musical Instrument Co., Ltd.
35 Lao Shan Yi Cun
Shanghai 200120
China
Tel: +86-21-58820000
Fax: +86-21-58783113
Email: huaxin@huaxin-music.com
www.huaxin-music.com

Rev. 1.02